

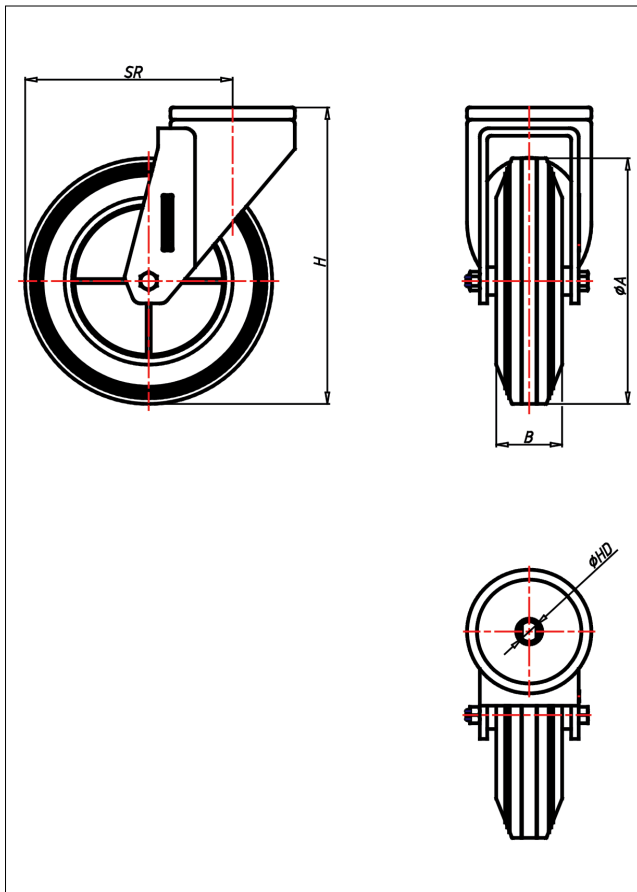

CR-CK/CB

Lenkrolle



CR-C



LENKROLLE	LENKROLLE MIT TOTALFESTSTELLER																			
<ul style="list-style-type: none"> • geräuscharmer Lauf • großer Fahrkomfort • beständig gegen verdünnte Säuren Vollgummi schwarz Felge Stahlblech verzinkt → Seite 205	<ul style="list-style-type: none"> • zweifaches Kugellager - vernietet • Stahlkugeln gehärtet • Radachse verschraubt, verzinkt → Seite 62	AUSWAHLHILFE: <table border="0"> <tr> <td>◀</td> <td>+</td> <td>+</td> </tr> <tr> <td>leicht lenkend</td> <td>X</td> <td>X</td> </tr> <tr> <td>verschleißarm</td> <td>X</td> <td>X</td> </tr> <tr> <td>stoßfest</td> <td>X</td> <td>X</td> </tr> <tr> <td>bodenschonend</td> <td>X</td> <td>X</td> </tr> <tr> <td>witterungsbeständig</td> <td>X</td> <td>X</td> </tr> </table>	◀	+	+	leicht lenkend	X	X	verschleißarm	X	X	stoßfest	X	X	bodenschonend	X	X	witterungsbeständig	X	X
◀	+	+																		
leicht lenkend	X	X																		
verschleißarm	X	X																		
stoßfest	X	X																		
bodenschonend	X	X																		
witterungsbeständig	X	X																		

Technische Details

ORDERNO (Artikel-nummer)	CR 160 CB
WDAB (Rad-Ø A x Breite B / mm)	160x40
LC (Tragkraft / kg)	180
H (Bauhöhe H / mm)	191
HD (Loch-Ø / mm)	12.5
SR (Schwenkradius / mm)	131
WB (Radlager)	Rollenlager